

A photograph of a modern swimming pool area. The pool is rectangular with a white concrete deck. In the foreground, there's a wooden deck with a metal handrail leading into the water. The pool is surrounded by several palm trees of varying heights. In the background, there are lounge chairs and a building with a light-colored, textured facade. The sky is clear and blue.

SWIMMING POOL DEHUMIDIFIERS
AND HEAT PUMPS

*“We conceive new possibilities,
shape new technologies,
and make our products forerunners.”*



Ing. Tibor Kovacs, CEO

INTERNATIONAL SALES NETWORK



From its foundation in 1992, MICROWELL Ltd. is firmly present on the global market, with 750 distributors and partners in 30+ countries across Europe, Russia, Middle East and North Africa.

All products are proudly developed and manufactured in Slovakia.

Slovakia is European Union, Schengen area and Eurozone member.

MICROWELL MILESTONES

2018

Microwell launches production of DRY SIREN 2nd generation.
New line of heat pumps GREEN LINE with R32 refrigerant is introduced.
DRY SIREN successfully installed in numerous pools in 5 countries.
New high-tech testing facility for heat pumps built.

2015

Microwell celebrates 25 years!
Start of development of new revolutionary concept of DRY SIREN dehumidifier.
New production site in operation.

2011

DRY 500 Metal swimming pool dehumidifier awarded Product of the year at Aquatherm Slovakia.
Hungarian subsidiary with an office in Budapest is established. Swimming pool heat pumps are exported to Poland.

2009

Dehumidifiers are sold to England and Bulgaria.
First heat pumps for Slovak and Czech customers are produced.

2005

Microwell opens distribution of swimming pool dehumidifiers in Germany.
DRY 500 Metal swimming pool dehumidifier is awarded Product of the year prize at Aquatherm Slovakia exhibition.

2002

Business is expanded to Hungarian market.
With subsidiaries in Prague, Brno and Ostrava company is expanding to the Czech Republic.

1992

The first swimming pool dehumidifier is manufactured, and with it, the third business division is established.
Microwell is established as a single business division company, specialising in industrial measurement systems.

2019

2017

2013

2010

2006

2003

2001

HOW WE WORK

INNOVATIVE SOLUTIONS & TECHNOLOGICAL ADVANTAGE

Microwell develops and manufactures well-rounded product assortment with two key specialisation areas - **dehumidification and heating systems**. Through continuous improvement and permanent focus on our customer, our products achieve results that push them in the lead. Ingrained in every step of the development process from research to assembly and final installation, Microwell products display innovation, sophisticated engineering, outstanding quality and craftsmanship. Distinguished as trendsetters, Microwell products are built on our core commitment. We are committed to efficiency.

EFFICIENCY THAT MATTERS

We constantly focus on energy efficiency in each part of our products. Our goal is to be the most energy efficient on the market being able to save money on energy bill for our customers every day. Our products are equipped with features unique to Microwell machines.



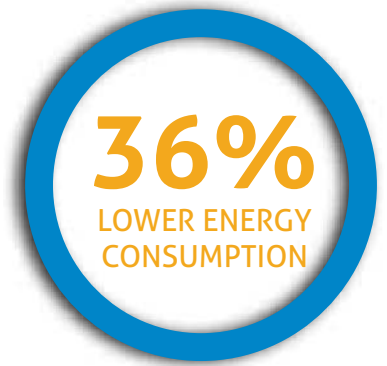
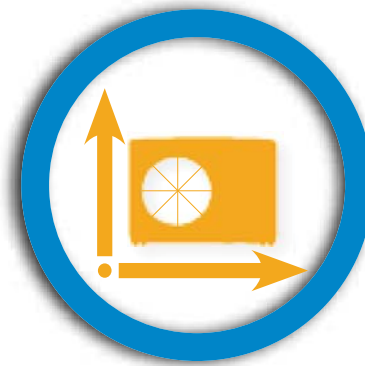

LEADING TECHNOLOGY

SMARTER FUNCTIONALITY

APPEALING DESIGN

GREATER PRODUCT RANGE

HIGHER MONEY SAVING

Based on a review done in 2016 and ISO17025 lab testing of products by various manufacturers across all models, Microwell devices came on top, outperforming the others by **up to 30%**. Our machines are better, more powerful and of higher quality.*

Inspired by the pace of progress, all Microwell products are continuously evolving to reach the full potential of ultimate usability, intuitive operation, feature sophistication and compliance to all the most challenging demands and expectations.

Microwell product design is recognised in **more than 30** countries globally. Over the years products have been awarded several prizes. Thanks to wide make & finish options our products can blend in, stand out or perfectly fit in any environment.

Based on close relationship with customers, Microwell provides functionality and benefits that consumers desire throughout matchless selection of products, their make, design and accessory options. There is no pool or customer that could not be served by a Microwell product.

Thanks to outstanding design, leading technology and up-to-date concepts, Microwell products achieve **up to 36%** lower* energy consumption than the others. Our product saves you money every day and helps to keep your bill under control.

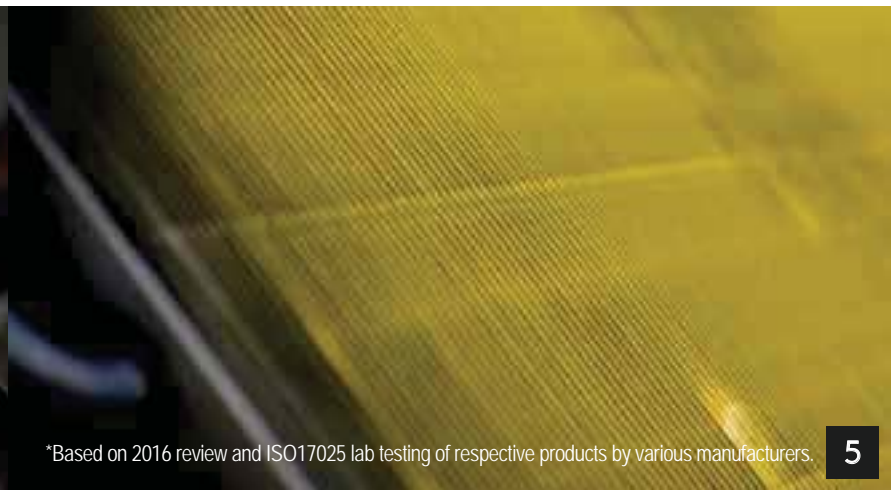

*Based on 2016 review and ISO17025 lab testing of respective products by various manufacturers.



We develop intelligent products
with inspiring efficiency performance
for superior experiences.

PRODUCTS

DRY SIREN - CEILING SWIMMING POOL DEHUMIDIFIER

SWIMMING POOL DEHUMIDIFIERS

HIGH CAPACITY POOL DEHUMIDIFIERS

INDUSTRIAL DEHUMIDIFIERS

MUSEUM DEHUMIDIFIERS

SWIMMING POOL HEAT PUMPS

QMAX HEAT PUMP TESTER

DRY ACCESSORIES

HP ACCESSORIES

MICRO+



DRY SIREN

Breathtaking dehumidifier
with extra features

DRY SIREN mono



FAMILY POOL

up to 60 m²

DRY SIREN due

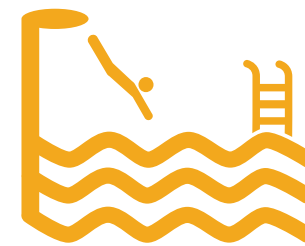

WELLNESS HOTEL POOL

up to 120 m²

MICROWELL DRY SIREN is the ultimate superstar, the first ceiling swimming pool dehumidifier in the world. Combining all what Microwell technology has to offer, DRY SIREN is an intelligent and visually captivating solution of paramount performance, setting a new tide in the industry.

DRY SIREN OF NEXT GENERATION

THE SECOND GENERATION OF DRY SIREN BRINGS NEW UNIQUE FEATURES:

- Internet connectivity & microSAFETY+ with AI.
- Faster App pairing
- Easier installation
- New outdoor unit with display
- New generation of motherboard



MOTHERBOARD 1ST GENERATION



MOTHERBOARD 2ND GENERATION



5 PRODUCTS IN 1

Ideal humidity

Low humidity



DEHUMIDIFIER 



microLIGHT+ 



LOUDSPEAKER 

High humidity



ONLINE SUPERVISION 



LED LAMP 

SEE DRY SIREN IN



FULL CONTROL

DRY SIREN mobile application allows you to actively take control of dehumidification process, LED lamp, Bluetooth speaker, microLIGHT+ and unit's self-diagnosis. From anywhere in the world, anytime, you are able to observe your unit's current status and air relative humidity and air temperature.

NO NOISE OR VIBRATION

DRY SIREN is a split dehumidifier with the compressor out of pool hall. The only sound you can hear while the unit is running is a DC fan. This is extremely quiet (35dB(A) from 1m).

DRY SIREN 2ND GENERATION

DRY SIREN HIGHLIGHTS

microSAFETY+
Supervision system

WIFI CONTROLLED
Full control over WIFI

AIR FAN
Radial DC fan LG
microENERGY+

microLIGHT+
Intuitive humidity reading

LED LIGHT
50W dimmable (warm to cool)
from 3000K to 7500K

DRAIN PUMP
40 cm vertical discharge

COVER
Oxidation resistant Acryl
UV stable

ON/OFF COMPRESSOR
Energy class A+
Quiet operation
microCOMPRESSOR+

AIR EXCHANGER
Aluminium gold fin epoxid,
100% corrosion free

BLUETOOTH LOUDSPEAKER
Music is played via Bluetooth
80W



LIGHT TEMPERATURE RANGE

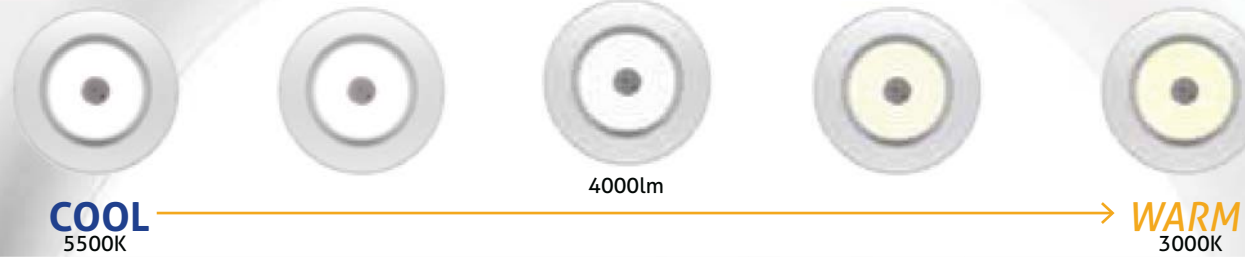

INSTALLATION

DRY SIREN is a **split** dehumidifier with ceiling unit and compressor unit. Ceiling unit is equipped with evaporator, condenser, fan, Bluetooth speaker, LED light and microLIGHT+. Ceiling units are connected to compressor unit with refrigerant copper tubes.

CEILING UNIT PLACEMENT

Ceiling unit is designed to be fixed directly on **concrete** or **wooden** ceiling structure or into lower **gypsun** ceiling using adjustable bar.

CONDENSATE DRAIN

DRY SIREN ceiling unit is equipped with condensation drain pump with 40 cm vertical discharge. The pump is of energy A+ class.

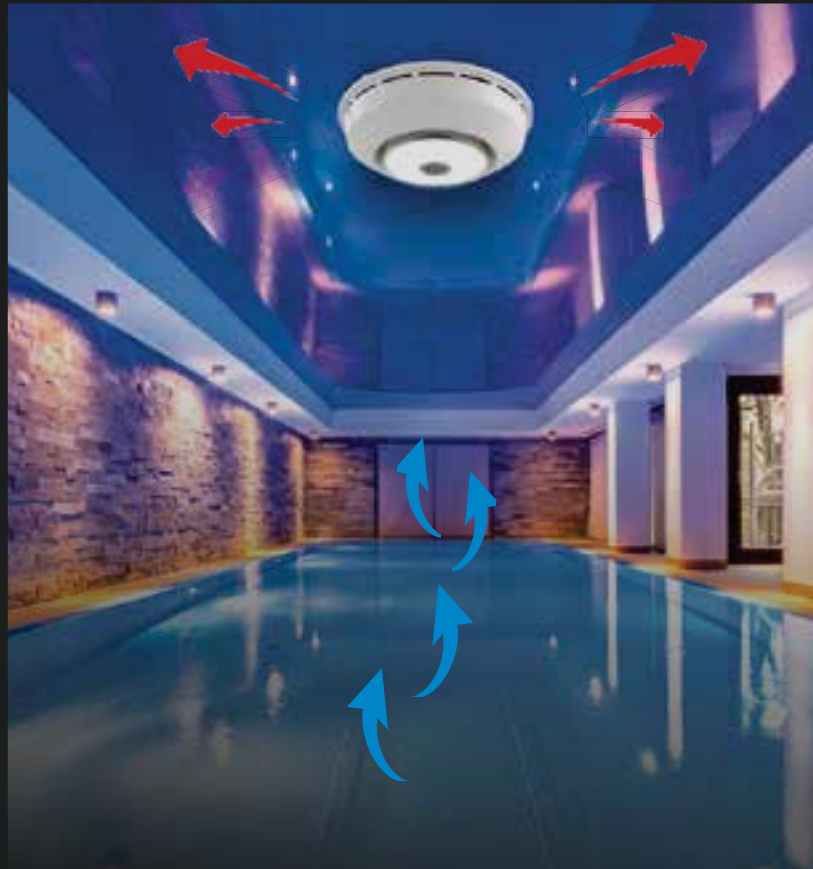

EXTRACTION
RATE*
67-134
liters

AIR
FLOW
1000-2000
m³/h

HEAT
RECOVERY
8750
W

EXPERIENCE FUTURE TODAY

microSAFETY+ is a supervision system in DRY SIREN models. The system monitors each DRY SIREN. In the case of a sign of technical problem or possible malfunction, the system creates a report and automatically sends it to Microwell. microSAFETY+ effectively protects your property 24/7. The data is securely ciphered.

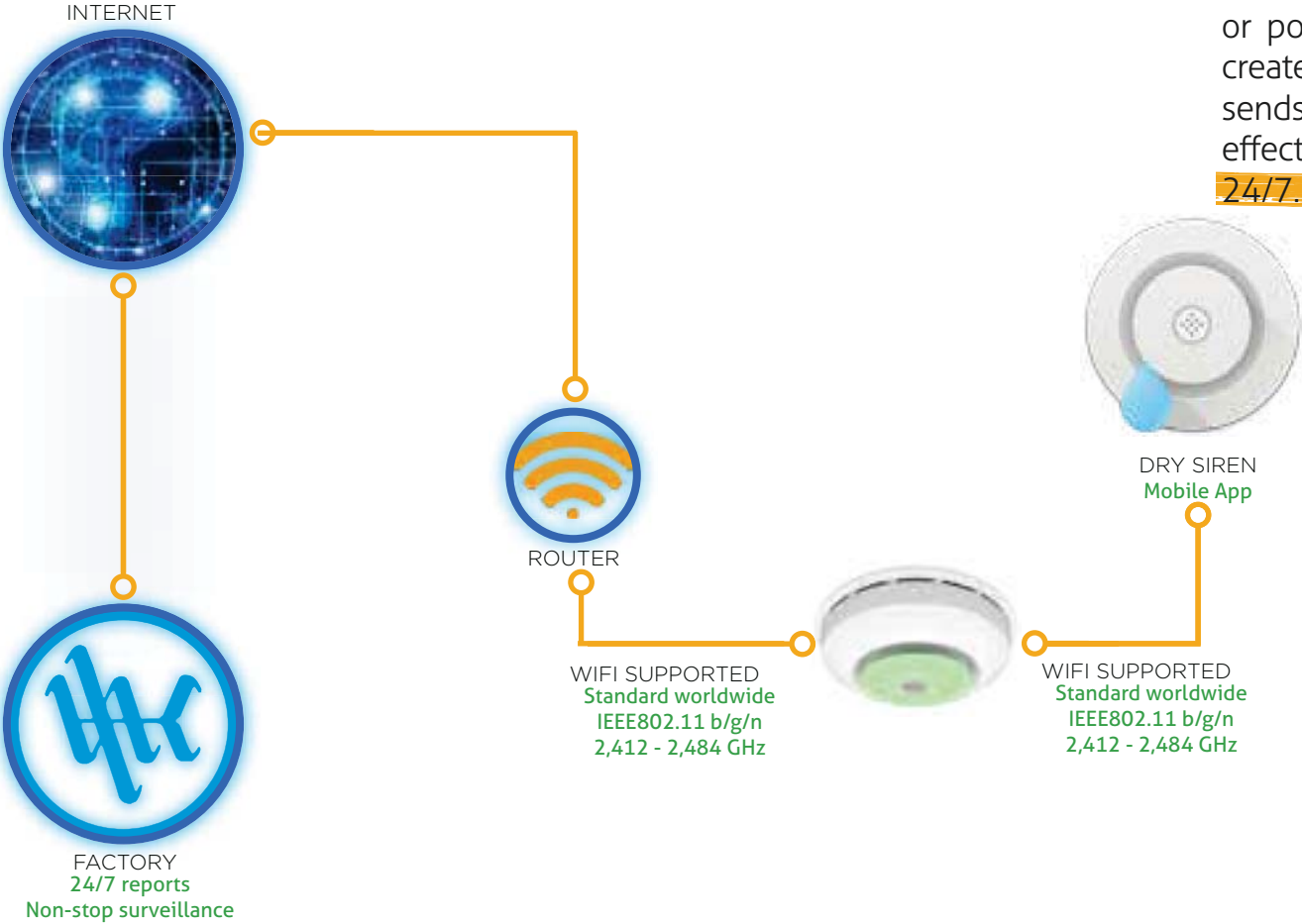

24/7
SUPERVISION

ONLINE
DIAGNOSTICS

PROTECTED
DATA

WIFI
FULL CONTROL

microSAFETY+





	Pool surface	Extraction rate 30°C / 60%RH	Extraction rate 30°C / 80%RH	Air flow	Noise level (at 1 m dist.)	Power consumption	Compressor	Heat output	Refrigerant	Dimensions netto (W x H x D)	Weight netto / brutto
SERIES	m ²	l/24hrs	l/24hrs	m ³ /h / Pa	dB (A)	W		W		mm	kg
DRY SIREN mono	60	67	104	1000	35	1200	ON/OF	4500	R410A	Ceiling unit 1205 x 278 Compressor unit 251 x 467 x 404	40 / 46
DRY SIREN due	120	134	208	2000	35	2300	ON/OF	8750	R 410 A	Ceiling unit 1205 x 278 Compressor unit 251 x 467 x 404	50 / 56

SWIMMING POOL DEHUMIDIFIERS



- » Dehumidify
 - » Heat
 - » Ventilate
- with one device

DRY 300 | DRY 400



FAMILY + JACUZZI POOL + STEM SAUNA

up to 30 m² ————— up to 45 m²

DRY 500



FAMILY POOL

————— up to 60 m²

DRY 800

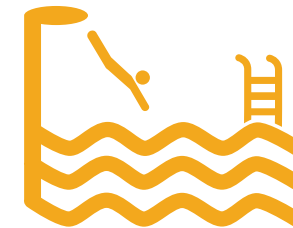

WELLNESS HOTEL POOL

up to 90 m² ————— up to 120 m²



MICROWELL DRY

Microwell dehumidifiers solve humidity problems and maintain healthy environment by removing condensation and vapor.

HEAT RECOVERY

Every dehumidifier is built on heat recovery principle providing up to **3.5 times** more energy than it consumes.

**0.05€
per liter**

at average rate
0,15 € / kWh

+5°C | +42°C

application

EXTRA

accessories and
finishes

FRESH AIR

100 - 300 m³/h

**HEAT
RECOVERY**

TRY 360° VIEW



Specially developed dehumidifiers for residential and hotel pools, spa and jacuzzi.

DRY DEHUMIDIFIERS ARE INSTALLED IN:

- Swimming Pools
- Spas
- Hotels and Wellnesses
- Hot tubs and Jacuzzis
- Fitness clubs
- Gyms
- Museums and archives
- Warehouses
- Drying rooms for laundry, breweries
- Military storages
- Bakeries
- Wine cellars

DEHUMIDIFIER HIGHLIGHTS

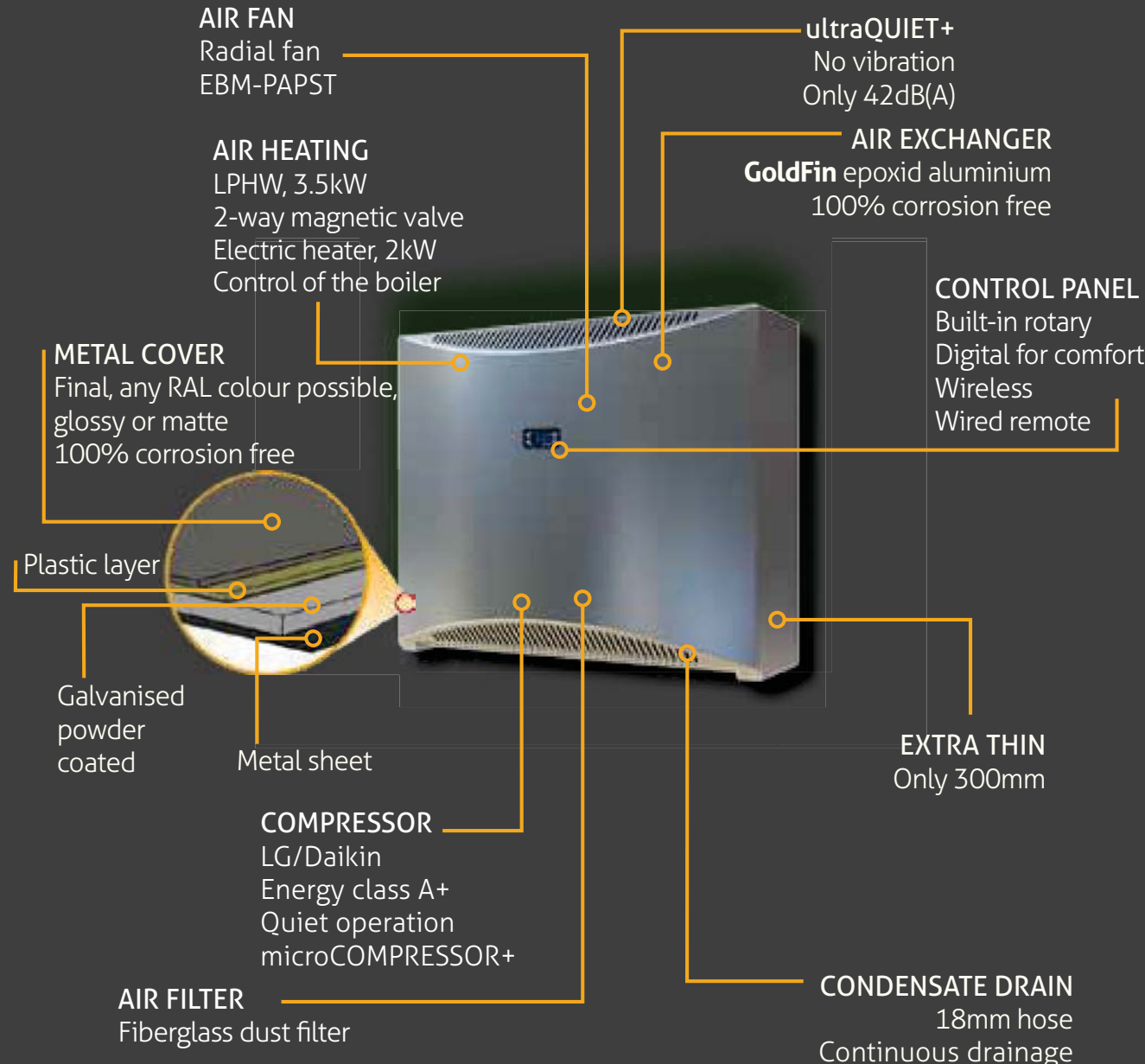

ATTRACTIVENESS TAILORED

Technologically advanced DRY swimming pool dehumidifiers with their trendy appearance are made to satisfy high expectations of pool owners. Offering an extensive selection of cover materials, accessories and colours.

PLENTY OF OPTIONS

Microwell DRY swimming pool dehumidifiers are designed with the customer in mind. Built with best materials and carefully executed processes on every step of product development. For customer's satisfaction, we offer consultations and widest tailoring options.

WIDE COLORS OPTIONS

Enjoy the experience of a custom-made piece of the art dehumidifier in your pool or in your customer's pool. Why would you have only a box shaped machine placed in your swimming pool hall if you can have a piece of furniture designed according to your own taste and needs? Microwell offers the widest range of colors on the market.

We normally have 200+ colors in stock. Colouring based on our customers' own choice is free of charge and can be done typically within 48 hours. You can specify your desired color according to international RAL color coding.

COMPATIBILITY
All DRY Metal range





DRY 300 | 400

up to 45 m² pool

FAMILY + JACUZZI POOL + STEAM SAUNA

WAVE

- wall mounted / mobile
- economy model
- acryl cover
- full set of options



METAL

- wall mounted / mobile
- exclusive
- metal cover
- any colors possible



SILVER

- wall mounted / mobile
- luxury
- 316L stainless steel
- full set of options



DUCT

- ducted / concealed
- 200 Pa
- up to 30 m ducting
- full set of options
- Silent comfort



THROUGH-THE-WALL (TTW)

- wall mounted
- behind the wall
- indoor/outdoor installation
- aluminium grills
- wall thickness up to 400 mm



DRY 300
WALL MOUNTED

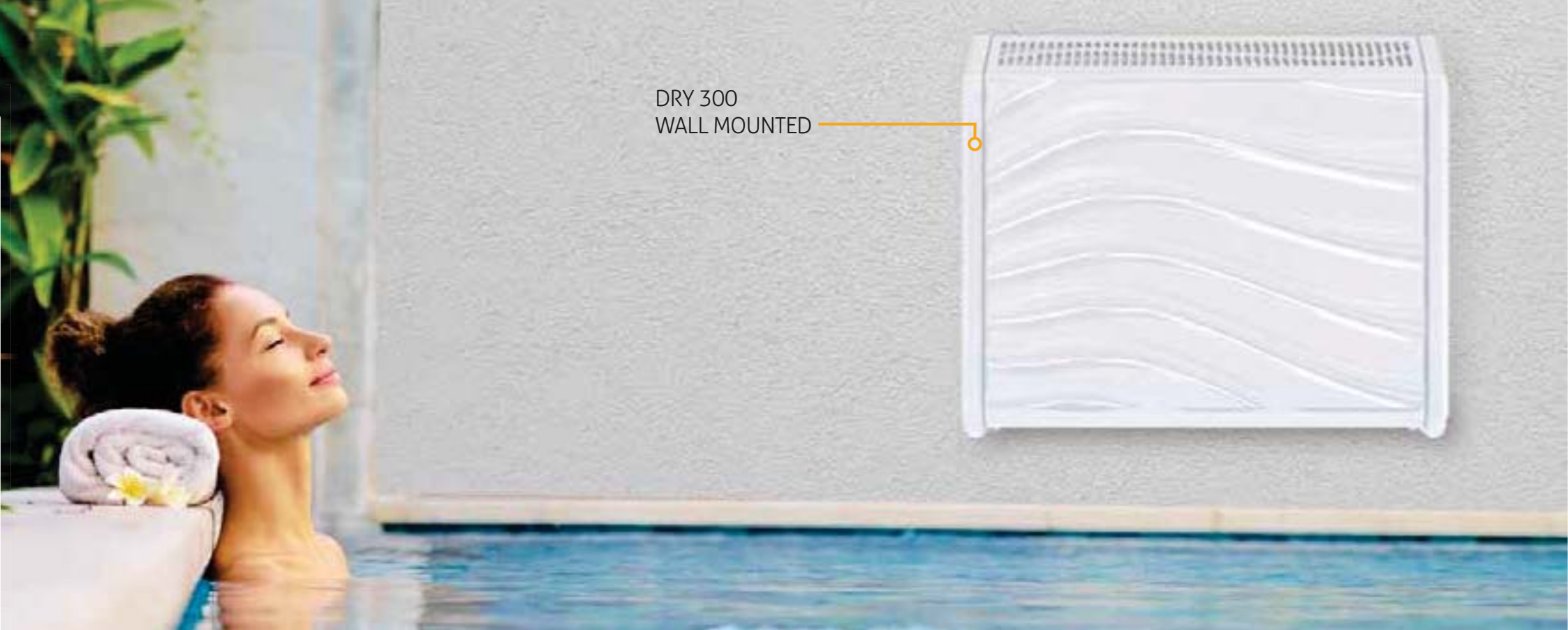

		Pool surface	Extraction rate 30°C / 60%RH	Extraction rate 30°C / 80%RH	Air flow	Noise level (at 1 m dist.)	Power consumption	Heat output	Refrigerant	Dimensions netto (W x H x D)	Weight netto / brutto
SERIES	Model	m ²	l/24hrs	l/24hrs	m ³ /h / Pa	dB (A)	W	W		mm	kg
DRY 300	WAVE	30	36	48	550	42	700	1900	R410A	780 x 660 x 255	40 / 46
	SILVER									780 x 642 x 300	50 / 56
	METAL									780 x 660 x 255	40 / 46
	TTW									780 x 660 x 255	40 / 46
	DUCT	30	32	43	500/200	54	800				
DRY 400	WAVE	45	48	58	600	42	700	1900	R410A	780 x 660 x 255	40 / 46
	SILVER									780 x 642 x 300	50 / 56
	METAL									780 x 660 x 255	40 / 46
		TTW	40	43	56	500/200	54	800			
		DUCT									



DRY 500

up to 60 m² pool

FAMILY + RESIDENTIAL POOL

WAVE

- wall mounted / mobile
- economy model
- acryl cover
- full set of options

METAL

- wall mounted / mobile
- exclusive
- metal cover
- any colors possible

SILVER

- wall mounted / mobile
- luxury
- 316L stainless steel
- full set of options

DUCT

- ducted / concealed
- 200 Pa
- up to 30 m ducting
- full set of options
- Silent comfort

THROUGH-THE-WALL (TTW)

- wall mounted
- behind the wall
- indoor/outdoor installation
- aluminium grills
- wall thickness up to 400 mm





DRY 500
MOBILE STAND
with **microLIGHT+**

		Pool surface	Extraction rate 30°C / 60%RH	Extraction rate 30°C / 80%RH	Air flow	Noise level (at 1 m dist.)	Power consumption	Heat output	Refrigerant	Dimensions netto (W x H x D)	Weight netto / brutto
SERIES	Model	m ²	l/24hrs	l/24hrs	m ³ /h / Pa	dB (A)	W	W		mm	kg
DRY 500	WAVE	60	66	101	800	44	1000	3500	R410A	1245 x 660 x 255	60 / 73
	SILVER									1245 x 660 x 300	77 / 90
	METAL									1245 x 660 x 255	60 / 73
	TTW	1245 x 660 x 253	60 / 73								
	DUCT	50	52	68	1000 / 200	56	1150	3500		1245 x 660 x 253	75 / 88

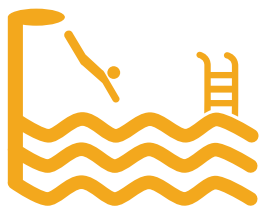

WELLNESS HOTEL POOL

DRY 800 | 1200

up to 120 m² pool

WAVE

- floor / wall mounted
- economy model
- acryl cover
- full set of options



METAL

- floor / wall mounted
- exclusive
- metal cover
- any colors possible



DUCT

- ducted / concealed
- 200 Pa/ up to 30 m ducting
- full set of options
- Silent comfort



THROUGH-THE-WALL (TTW)

- floor / wall mounted
- behind the wall
- indoor/outdoor installation
- aluminium grills
- wall thickness up to 400 mm



CEILING GRILLS

DEHUMIDIFIER IN
TECHNICAL ROOM

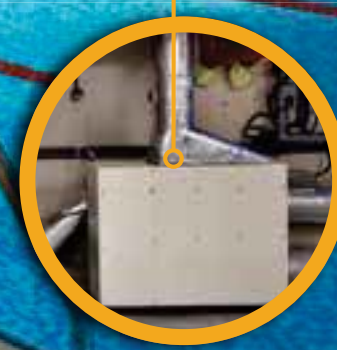

		Pool surface	Extraction rate 30°C / 60%RH	Extraction rate 30°C / 80%RH	Air flow	Noise level (at 1 m dist.)	Power consumption	Heat output	Refrigerant	Dimensions netto (W x H x D)	Weight netto / brutto
SERIES	Model	m ²	l/24hrs	l/24hrs	m ³ /h / Pa	dB (A)	W	W		mm	kg
DRY 800	METAL	90	90	136	1100	46	1600	5100	R410A	1250 x 950 x 310	100 / 133
	WAVE									1250 x 950 x 310	80/113
	TTW	80	88	135	1100 / 170	58	1700	5100		1247 x 950 x 300	100 / 133
	DUCT									102 / 135	
DRY 1200	METAL	120	120	181	1200	46	2150	5250	R410A	1250 x 950 x 310	104 / 136
	WAVE									1250 x 950 x 310	80/113
	TTW	110	112	170	1200 / 145	60	2250	5250		1247 x 950 x 300	103 / 136
	DUCT										

Aluminium floor air grills

Floor air ducting system, used with ducted dehumidifiers, made from magnesium aluminium compound (AlMg). Built to last.

MODELS

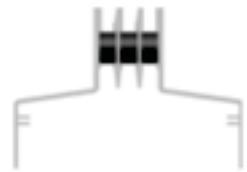

SYMMETRICAL



ASYMMETRICAL



REMOVABLE ASR

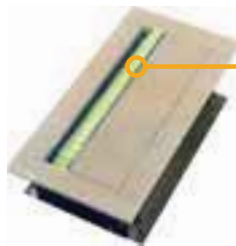

REMOVABLE ASR
LED LINE

microLIGHT+

COMPATIBILITY

ALL MICROWELL and NON-MICROWELL dehumidifiers

**FULL
FLEXIBILITY**

4 models
adjustable height
cleanable

**EASY
TO CLEAN**

Removable

FULL FLEXIBILITY OF PRODUCT OPTIONS

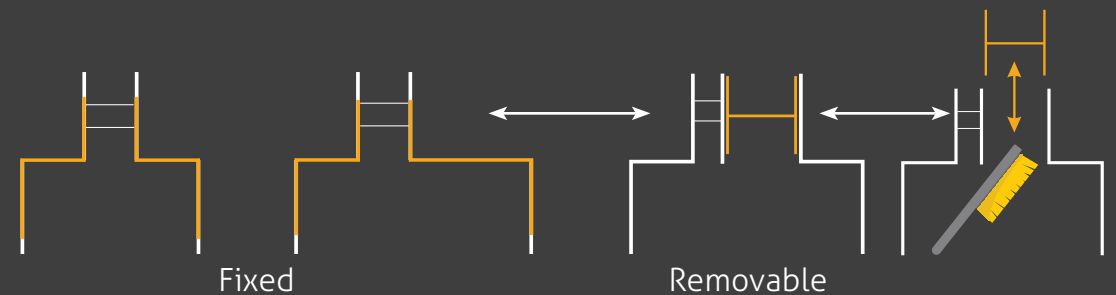
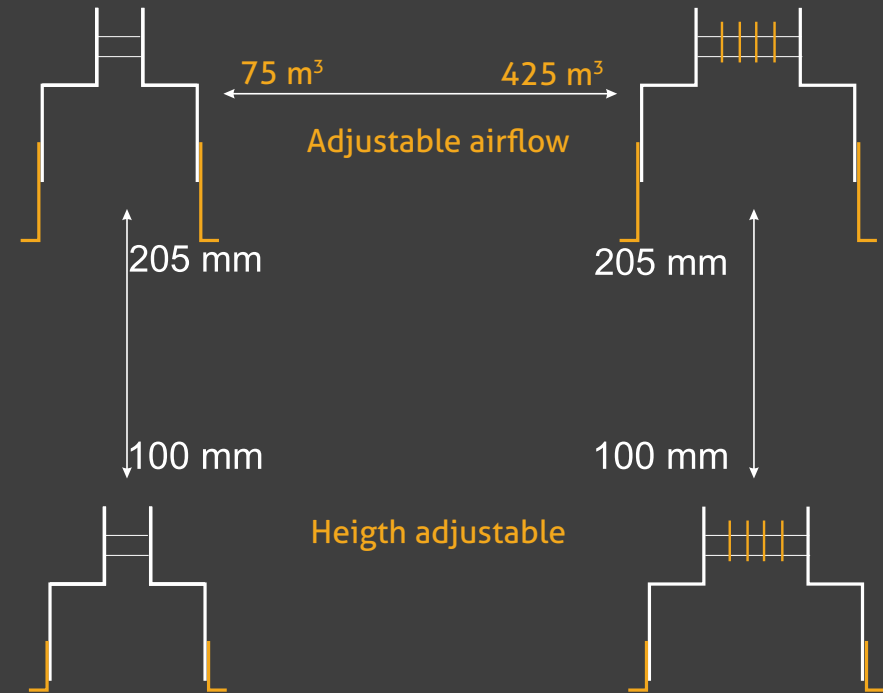



Architecturally integrated
No radiators in the swimming hall required

75-425m³/h per 1 meter
Air Flow

Corrosion resistant
Manufactured from aluminum AlMg

Model	ASS/ASU/ASR 1	ASS/ASU2/ASR 2	ASS/ASU/ASR 3	ASS/ASU/ASR 4	ASS/ASU/ASR 5
Number of slots (pcs)	1	2	3	4	5
Effective slot width (mm)	8	16	24	32	40
Recommended air flow (m ³ /h per running meter)	75	150	225	300	375
Maximum air flow (m ³ /h per running meter)	85	170	225	340	425

CHEMICAL RESISTANCE: FREE CHLORINE RANGE PPM 1.0-3.0, SUPERCHLORINATION PPM MAX. 30 PPM/MAX. 24 HOURS ACIDITY / PH LEVEL: PH 7.4 +/- 0.4 MAXIMAL SALINE CONTENT WT/WT 6%

Microwell reserves the right to change the technical data without notice.



FRESH AIR ventilation



Our Innovation **FRESH AIR SUPPLY**

MICROWELL additional ventilation

Each Microwell dehumidifier has fresh air supply possibility. The air inlet is located under the condenser, that way the incoming fresh air is effectively heated at no cost thanks to heat recovery.

INSTALLATION SCHEME

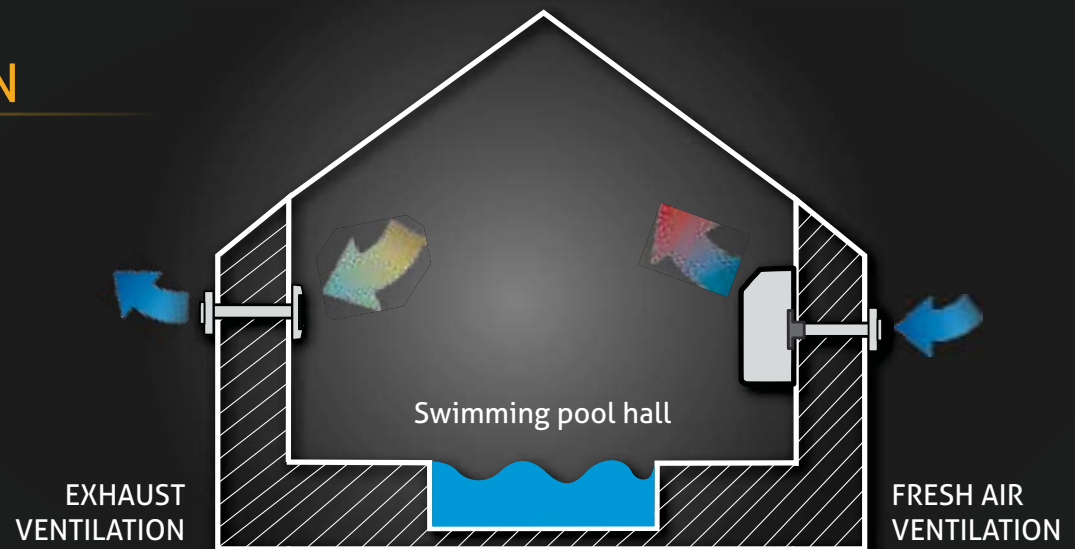



up to
300 m³/h

**Bring fresh air into your pool
and warm it with the dehumidifier.**

FREE
heated



FRESH AIR ventilation

EXHAUST ventilation set

Includes: Small axial extract fan, Backdraft shutters, Connection - 3pcs, Plastic external louver, Plastic circular hose



FRESH AIR ventilation set

Includes: Fresh air metal extension for connection to dehumidifier, Plastic external louver / Electric plastic back draft louvre shutter, Plastic circular hose

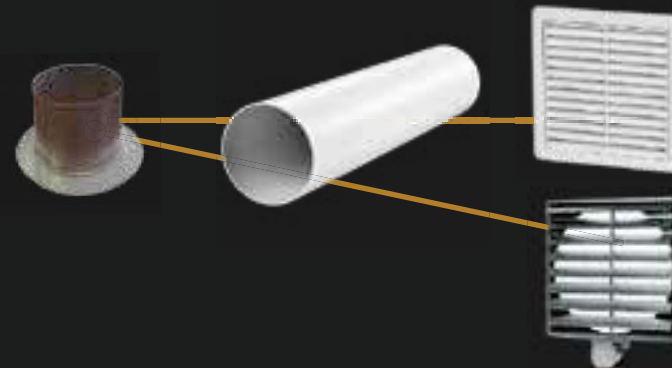

HEALTH & PROPERTY protection



Real time measurement of humidity in LED color scale

Microwell microLIGHT+ is a unique LED technology, designed for accurate measurement and intuitive reading of humidity level present in indoor environment. Working on the principle of relative humidity reading, microLIGHT+ uses LED light to project color instead of a measured figure. The color moves in continuous gradient.

- Blue LED light indicates a low level of relative humidity.
- Green LED light marks an ideal range of relative humidity.
- Red LED light indicates a high level of relative humidity.



microLIGHT+

- Quickly and accurately measures the current relative humidity in any indoor environment.
- Automatically reflects relative humidity by changing the color gradient between blue, green and red color.
- Uses multi-LED light system to transmit gathered information.
- Notifies the level of relative microclimate humidity in real time.

without microLIGHT+





microLIGHT+ applications

- **microLIGHT+**

Accessory for all MICROWELL dehumidifiers operation temperature range: 0°C ... +60°C

- **microLIGHT+ LAMP**

Freestanding table lamp, that can be placed anywhere in the room.

- **microSTEAM+**

LED humidistat designed for ceilings of the swimming pool halls or wellnesses and saunas. operation temperature range: 0°C ... +120°C

Excessive humidity in living areas has a damaging effect on personal health, and it also affects living conditions at home. Moisture in the form of vapour condensation and general dampness is the main cause for the growth of mould, bacteria and bad odour. Prolonged exposure has a bad effect on personal health and general quality of life.

microLIGHT+

Humidity you can see...

micro LIGHT +

HIGH HUMIDITY
60-100
%Rh

IDEAL HUMIDITY
40-60
%Rh

LOW HUMIDITY
0-40
%Rh



microLIGHT+



microLIGHT+ LAMP



microSTEAM+



REMOTE WIRELESS HUMIDISTAT & THERMOSTAT

EASY 300 is a remote **wireless** device for monitoring and controlling humidity and air temperature.

- **30 meters** distance in buildings
- **100 meters** outdoor
- humidistat & thermostat
- **golden 24 carat** galvanized contacts



COMPATIBILITY
All DRY range

REMOTE WIRED HUMIDISTAT

HYG 6001 is a remote **wired** device for monitoring and controlling of humidity. The unit is mounted on **any surface** and at **any distance** from a dehumidifier.

- range **30%** to **100% RH**



COMPATIBILITY
All DRY range

BUILT-IN DIGITAL HUMIDISTAT & THERMOSTAT

Built-in digital **humidistat & thermostat** is a convenient, accurate solution for temperature and humidity control. It is supplied by standard to Metal, Silver & Duct models

- installation on dehumidifier
- simple operation
- range **5%** to **100% RH**



COMPATIBILITY
All DRY range

HIGH TEMP SPA SET UP TO 42°C

Thermostatic expansion valve, Spa set, prevents the overheating, and allows the dehumidifier to work effectively in ambient air temperature up to 42°C. This is effective mainly in spa and sauna areas.



COMPATIBILITY
All DRY 300 and DRY 500 models

ANTIFREEZE SET FROM +15°C

Outdoor pool set is primarily designed for outdoor pools with cover. Thanks to antifreeze thermostat, it allows a dehumidifier to work effectively in ambient temperatures down to +15°C. Outdoor pool set can be used with a Spa set to create the widest operational temperature range from +15°C to +42°C.



COMPATIBILITY
All DRY range

LOW TEMP SET FROM +5°C

Microwell dehumidifiers can be equipped with a hot gas defrost function to provide with an effective humidity control by ambient air temperatures from +5°C. Hot gas defrost is used in permanent low air temperature applications.



COMPATIBILITY
All DRY 300 and DRY 500 models

The widest selection of models, finishes and accessories.

DRY ACCESSORIES

AIR HEATING

WATER & ELECTRICAL UP TO 7 KW

Each Microwell dehumidifier can be equipped with an additional air heating.

- 3 options of connection
- Low Pressure Hot Water (LPHW) up to 7kW
- Electrical heater up to 3kW

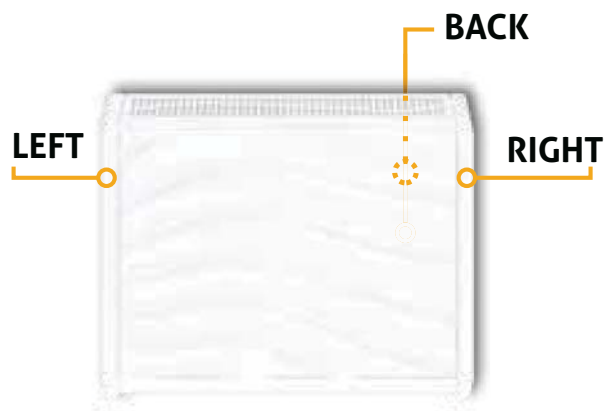

COMPATIBILITY
All DRY range

OUTDOOR INSTALLATION

Sometimes a specific set of pool parameters require a dehumidifier unit to be installed in exterior. Microwell offers a complete solution with 40mm aluminum covered insulation, condensate tray defrost and winter module allowing operations down to -15°C.



COMPATIBILITY
All DRY range

AIR FILTER

Each Microwell dehumidifier can be equipped with an effective air filter on demand. The structure is made from fiberglass supported on an aluminum frame categories:

- fluff/dust
- G3/G4



COMPATIBILITY
All DRY range

FROM ELEGANCE
TO *EXTRAVAGANCE*

HAVE YOUR COLOR
in 48 hours

		Pool surface	Extraction rate 30°C / 60%RH	Extraction rate 30°C / 80%RH	Air flow	Noise level (at 1 m dist.)	Power consumption	Heat output	Refrigerant	Dimensions netto (W x H x D)	Weight netto / brutto
SERIES	Model	m ²	l/24hrs	l/24hrs	m ³ /h / Pa	dB (A)	W	W		mm	kg
DRY 300	WAVE	30	36	48	550	42	700	1900	R410A	780 x 660 x 255	40 / 46
	SILVER									780 x 642 x 300	50 / 56
	METAL									885 x 660 x 250	40 / 46
	TTW										
	DUCT	30	32	43	500/200	54	800				
DRY 400	WAVE	45	48	58	600	42	700	1900	R410A	780 x 660 x 255	40 / 46
	SILVER									780 x 642 x 300	50 / 56
	METAL									885 x 660 x 250	40 / 46
	TTW										
	DUCT	40	43	56	500/200	54	800				
DRY 500	WAVE	60	66	101	800	44	1000	3500	R410A	1245 x 660 x 255	60 / 73
	SILVER									1245 x 660 x 300	77 / 90
	METAL									1245 x 660 x 255	60 / 73
	TTW										
	DUCT	50	52	68	1000 / 200	56	1150	3500			
DRY 800	METAL	90	90	136	1100	46	1600	5100	R410A	1250 x 950 x 310	100 / 133
	WAVE									1250 x 950 x 310	80 / 113
	TTW									1247 x 950 x 300	100 / 133
	DUCT	80	88	135	1100 / 170	58	1700	5100			
DRY 1200	METAL	120	120	181	1200	46	2150	5250	R410A	1250 x 950 x 310	104 / 136
	WAVE									1250 x 950 x 310	80 / 113
	TTW									1247 x 950 x 300	103 / 136
	DUCT	110	112	170	1200 / 145	60	2250				

Microwell reserves the right to change the technical data without notice.

STANDARD EQUIPMENT:

- Dehumidifier
- Wall console
- Fixation screws
- User manual
- Installation layout
- microCOMPRESSOR+

INSTALLATION OPTIONS:

- On the wall
- Through the wall
- On the floor
- Mobile
- Ducted

COLOUR OPTIONS:

- Metal in any RAL colour, glossy or matte finish

ACCESSORIES:

- Built-in mechanical humidistat
- Remote wireless humidistat-thermostat
- Remote wired humidistat
- LPHW without regulation
- LPHW up to 7kW + 2-way magnetic valve
- LPHW connection (back, right, left)
- Electric heater up to 4kW
- Control of the boiler
- microLIGHT+
- Cover selection
- Air filter

AIR TEMPERATURE RANGE:

- Standard range from 22°C to 35°C
- Antifreeze thermostat from 15°C to 35°C
- Thermostatic expansion valve from 22°C to 42°C
- Antifreeze thermostat with thermostatic expansion valve from 15°C to 42°C
- 4-valve hot gas defrost from 5°C to 35°C



Not sure about the right dehumidifier?

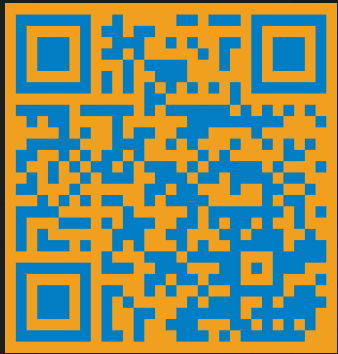

SCAN & GO



	Room temperature	<input type="text" value="30"/>	°C
	Required air humidity	<input type="text" value="60"/>	%Rh
	Pool temperature	<input type="text" value="28"/>	°C
	Pool surface	<input type="text" value="20"/>	m ²
	Pool hall volume	<input type="text" value="150"/>	m ³
	In use	<input type="text" value="2"/>	h

Try
online
calculator



SWIMMING POOL HEAT PUMPS

» Cooling
» Heating
with one device



ECONOMY LINE



up to 120 m³

PREMIUM LINE



up to 120 m³

GREEN|R32|LINE



up to 60 m³



MICROWELL HP range of swimming pool heat pumps is a full capacity range operating on the principle of renewable energy, designed for continuous and stable production of water heating or cooling in any pool environment. Their exceptional efficiency, low environment impact and low costs are the result of superior technology, putting them at the industry's forefront.

FULL YEAR
HEATING
-15°C | +40°C

**Automatic
HEATING
COOLING**
included

COP
up to 21.06
at Air 26°C/Water
26°C/ Humidity 80%

TRY 360° VIEW



Microwell heat pumps are designed for 15+ years livelihood. The product requires minimal maintenance. You only need to ensure cleanness of air exchanger from leaves, dust and other particles.

MICROWELL HEAT PUMPS ARE INSTALLED IN:

- Swimming Pools
- Spas
- Hotels and Wellnesses
- Hot tubs and Jacuzzis
- Fish industry
- Wine industry
- Horse healing

HP HIGHLIGHTS

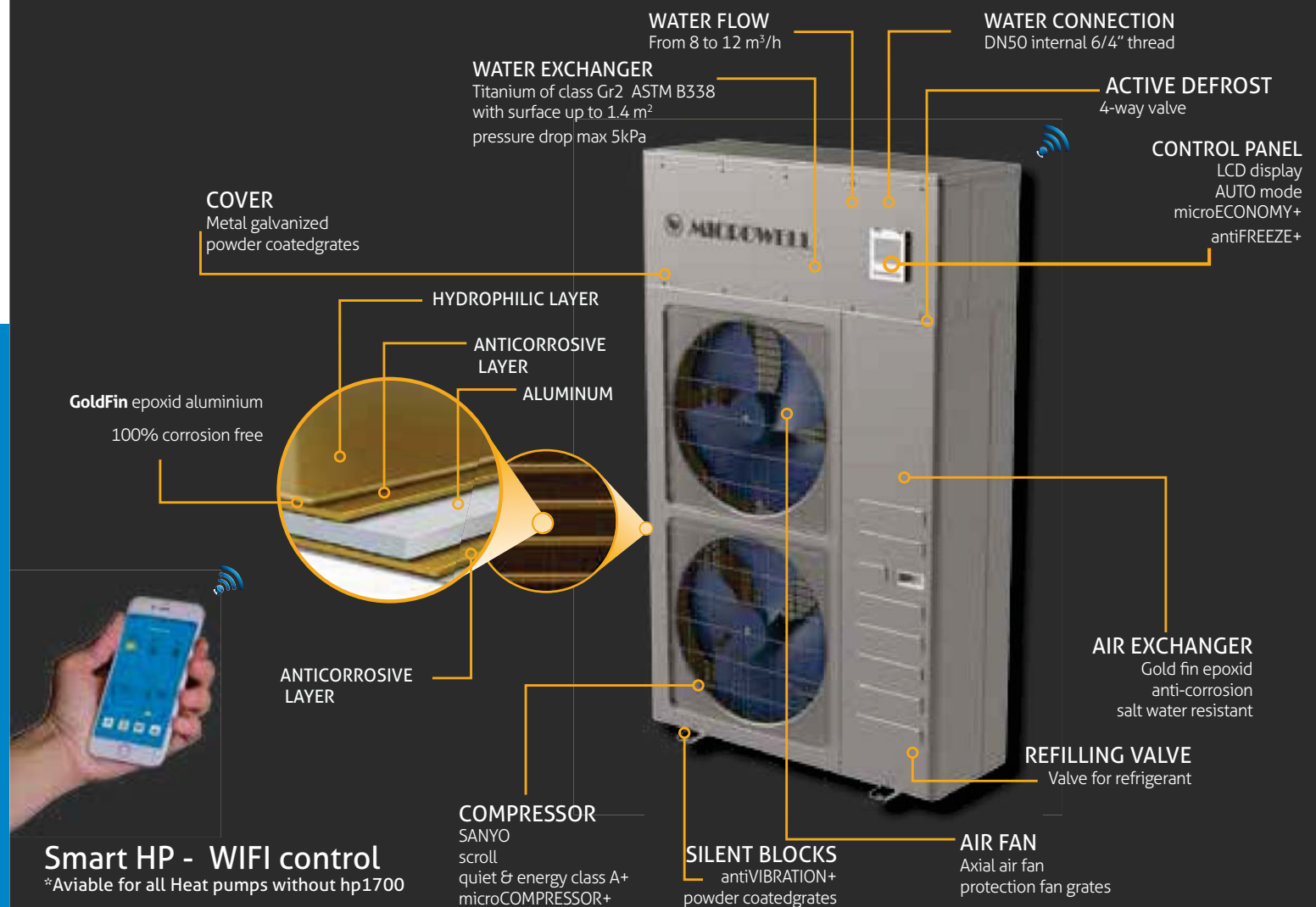

KEEP YOUR COMFORT UNDER CONTROL

WIFI
control
cooling | heating

**iOS/
Android**
available

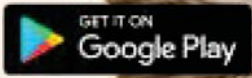

OMEGA HP 1000/1400

INVENTOR HP 2300/2800

COP
7.6

- Automatic cooling / heating
- Hot gas defrost is STANDARD
- **-15 °C to + 43 °C** ambient air temp application
- +5°C to + 60°C water temperature selection
- Higher performance thanks to **15% more titanium**
- Shorter heating time and operational costs
- Higher COP and greater performance



METAL
cover



COMPACT



SPLIT



SPLIT



COMPACT





MODEL	Pool capacity (cover / no cover)	Heating output (A26/W26/ 35 - 80%RH)	COP (A26/W26/ 35-80%RH)	Power consumption (A26/W26/63%RH)	Heating capacity (A26/W26/63%RH)	Cooling capacity (A30/W35)	Operating temperature	Water flow		Power supply	Heat exchanger	Titanium surface	Acoustic pressure level	Water circuit connection	Dimensions
	m ³	kW	COP	kW	kW	kW	°C	m ³ / h	kPa	V AC / ph	type	m ²	dB (A)	mm/inch/thread	width / height / length
HP 1000 Compact OMEGA	40 / 30	9.7 - 13.1	5.2 - 7.0	1.88	10.7	6.5	-15 to +40	4 - 6	5 - 15	230 / 1	Titanium Gr 2 ASTM B338	0.43	54/48/42/36	50 / 64 / internal	870x870x320
HP 1000 Split OMEGA					14.1	9.5		4 - 6	5 - 15						870x655x320
HP 1400 Compact OMEGA	60 / 40	12.8 - 17.2		2.47	23	20.1		8 - 10	5 - 15	400 / 3		0.48	55/49/43/37		870x870x320
HP 1400 Split OMEGA				28.4	25.0	4 - 6		5 - 15	870x655x320						
HP 2300 Compact INVENTOR	80 / 60	20.9 - 27.2	5.8 - 7.6	4.44	23	20.1		8 - 10	5 - 15	400 / 3		0.95	56/50/44/38		942x1550x360
HP 2300 Split INVENTOR				4.34	28.4	25.0		8 - 12	1 - 5						942x1250x360
HP 2800 Compact INVENTOR	120 / 80	25.8 - 33.5	5.8 - 7.6	4.34	28.4	25.0		8 - 12	1 - 5	400 / 3		1.1	56/50/44/38		942x1550x360
HP 2800 Split INVENTOR				4.34	28.4	25.0		8 - 12	1 - 5						942x1250x360

Microwell reserves the right to change the technical data without notice.

PREMIUM HP 1100/1500

PREMIUM HP 2400/3000

COP
8.5

- Ultimate performance thanks to the highest amount of titanium on the market (up to 40% more titanium than others)
- The shortest heating time
- The lowest operational costs
- Heat exchanger surface up to 1.4 m² of titanium
- Features no other unit has

METAL
cover



COMPACT



SPLIT



SPLIT



COMPACT





MODEL	Pool capacity (cover / no cover)	Heating output (A26/W26/ 35 - 80%RH)	COP (A26/W26/ 35-80%RH)	Power consumption (A26/W26/63%RH)	Heating capacity (A26/W26/63%RH)	Cooling capacity (A30/W35)	Operating temperature	Water flow		Power supply	Heat exchanger	Titanium surface	Acoustic pressure level	Water circuit connection	Dimensions
	m ³	kW	COP	kW	kW	kW	°C	m ³ / h	kPa	V AC / ph	type	m ²	dB (A)	mm/inch/ thread	width / height / length
HP 1100 Compact PREMIUM	40 / 30	10.3 - 13.9	5.9 - 7.9	1,74	11.3	7.2	0/+/-40	4 - 6	1 - 15	230 / 1	Titanium Gr 2 ASTM B338	0.56	54/48/42/36	50 / 64 / internal	870x870x320
HP 1100 Split PREMIUM															870x655x320
HP 1500 Compact PREMIUM	60 / 40	12.9 - 17.4		2,29	14.9	10,3		4 - 6	1 - 5	400 / 3		0.70	55/49/43/37		870x870x320
HP 1500 Split PREMIUM															870x655x320
HP 2400 Compact PREMIUM	80 / 60	20 - 27.2	6.5 - 8.5	3,51	24.4	21,7		8 - 10	1 - 5	56/50/44/38		1.2	942x1550x360		
HP 2400 Split PREMIUM													942x1250x360		
HP 3000 Compact PREMIUM	120 / 80	27.4 - 35.5	4,34	30.1	26.8	8 - 12		1 - 5	1.4	942x1550x360					
HP 3000 Split PREMIUM										942x1250x360					

GREEN HP 1000/1400

COP
6.7

- Automatic cooling / heating
- **Economy** fixed speed
- Hot gas defrost is STANDARD
- New environment friendly refrigerant R32

ABS
cover



COP
13.5

- Automatic cooling / heating
- **Premium** variable speed
- Hot gas defrost is STANDARD
- New environment friendly refrigerant R32
- **Full DC stepless compressor & fan**
- Expansion valve

ABS
cover



HP Inverter
Technology





MODEL	Pool capacity (cover / no cover)	Heating output (A26/W26/ 35 - 80%RH)	COP (A26/W26/ 35-80%RH)	Power consumption (A26/W26/63%RH)	Heating capacity (A26/W26/63%RH)	Cooling capacity (A30/W35)	Operating temperature	Water flow		Power supply	Heat exchanger	Titanium surface	Acoustic pressure level	Water circuit connection	Dimensions
	m ³	kW	COP	kW	kW	kW	°C	m ³ /h	kPa	V AC / ph	type	m ²	dB (A)	mm/inch/ thread	width / height / length
HP 1000 GREEN On-Off	40/30	9.9 - 13.1	5.4 - 6.5	1.92	10	6.8	-15 to +40	4 - 6	15	230 / 1	Titanium Gr 2 ASTM B338	0.42	52/43	50 / 6.4 / internal	1045 x 710 x 440
HP 1000 GREEN Inverter PRO		10.4 - 13.2	3.2 - 13.2	1.72	10.7	7.6		3.5	14			0.52	52/40		1050 x 709 x 440
HP 1400 GREEN On-Off	60/40	13.5 - 17.0	5.6 - 6.5	2.53	13	8.1		4 - 8	15			0.48	54/44		1045 x 710 x 440
HP 1400 GREEN Inverter PRO		12.7 - 16.8	3.7 - 13.5	2.09	12.8	9.5		4	14			0.7	54/40		1050 x 870 x 450

1 PHASE 21 kW HP 1700

- Automatic cooling / heating
- **Economy** fixed speed
- Hot gas defrost is STANDARD
- **Ideal for installations where 3-phase power supply is not existing**
- Designed for 70 m³ pool
- **Small in dimensions**
- Comes in COMPACT & SPLIT

COP
6.2

ABS
cover



COMPACT



SPLIT



	Pool capacity (cover / no cover)	Heating output (A26/W26/ 35 - 80%RH)	COP (A26/W26/ 35 - 80%RH)	Power consumption (A26/W26/63%RH)	Heating capacity (A26/W26/63%RH)	Cooling capacity (A30/W35)	Operating temperature	Water flow		Power supply	Heat ex-changer	Titanium surface	Acoustic pressure level	Water circuit connection	Dimensions
								m ³ / h	kPa						
HP 1700 COMPACT	70 / 50	14.7 - 21.2	4.6 - 6.2	3,47	17.01	12,21	-15 to +40	6 - 8	5 - 15	230 / 1	Titanium Gr 2 ASTM B338	0.95	56/50/43/39	50 / 6,4 / internal	1125 x 707 x 453
HP 1700 SPLIT															1125 x 707 x 453

TROPICAL up to 60 °C AIR

50% more effective than standard chiller

- Designed to heat & cool in extreme hot weather conditions
- Works in ambient air temperatures up to 60°C
- Ideal fo Middle East & North Africa
- Designed to combine up to 10 units in a single installation



COMPATIBILITY
HP OMEGA, INVENTOR, PREMIUM



MODEL	HP 1000 Compact OMEGA	HP 1000 Split OMEGA	HP 1400 Compact OMEGA	HP 1400 Split OMEGA	HP 1100 Compact PREMIUM	HP 1100 Split PREMIUM	HP 1500 Compact PREMIUM	HP 1500 Split PREMIUM	HP 1700 Compact	HP 1700 Compact	HP 2300 Compact INVENTOR	HP 2300 Split INVENTOR	HP 2800 Compact INVENTOR	HP 2800 Split INVENTOR
Cooling capacity (kW EER) A55W28RH15	6.2kW 2.3 EER	6.2kW 2.3 EER	7.8kW 2.3 EER	7.8kW 2.3 EER	6.7kW 2.5 EER	6.7kW 2.5 EER	8.5kW 2.5 EE R	8.5kW 2.5 EER	9.7kW 2.5 EER	9.5kW 2.5 EER	14.3kW 2.5 EER	14.3kW 2.5 EER	18.4kW 2.5 EER	18.4kW 2.5 EER
Cooling capacity (kW EER) A55W35RH15	6.7kW 2.4 EER	6.7kW 2.4 EER	8.5kW 2.4 EER	8.5kW 2.4 EER	7.4kW 2.6 EER	7.4kW 2.6 EER	9.2kW 2.6 EER	9.2kW 2.6 EER	10.5kW 2.6 EER	10.5kW 2.6 EER	15.1kW 2.6 EER	15.1kW 2.6 EER	19.8kW 2.6 EER	19.8kW 2.6 EER
Cooling capacity (kW EER) A60W28RH15	5.9kW 2.1 EER	5.9kW 2.1 EER	7.5kW 2.1 EER	7.5kW 2.1 EER	6.5kW 2.3 EER	6.5kW 2.3 EER	8.2kW 2.3 EER	8.2kW 2.3 EER	9.5kW 2.3 EER	9.5kW 2.3 EER	13.3kW 2.2 EER	13.3kW 2.2 EER	17.5kW 2.2 EER	17.5kW 2.2 EER

HP COMPACT & HP SPLIT

SPLIT ADVANTAGES:

- No noise & visual disturbance
- No winterizing
- Full year comfort
- Increased safety for children & hotel guests



WIFI SMART CONTROL

Microwell HP can be upgraded with a WIFI module. This includes small WIFI box enabling internet connection through **Android/iOS App**

- to control your swimming pool **24/7 from anywhere in the world**,
- be notified of an emergency situation,
- have constant ability to check the conditions of your pool.



COMPATIBILITY
All HP range except HP 1700

WINTER PACKAGE

Winter package prevents heat pumps from any damage during extremely cold weather. Winter module helps to extend operational air temperature range down **to -15°C**.

The package includes:

- Condensate tray defrost
- Heat exchanger frost protection
- Winter module



COMPATIBILITY
All HP range

PROTECTION COVER

Applied in a **non-operation period**, **protection cover** ensures protection of the heat pump during all seasons.



COMPATIBILITY
All HP range

SELF-CLEANING COLOR

Self-cleaning color is innovation by Microwell. The final finish is a special paint made on the basis of years of experience and the latest knowledge in the field of nanotechnology. Color has **microscopic film** on the surface of the heat pump, and washes away any dust with the first rain.



COMPATIBILITY
HP 2300 & 2800 range

GOLD FIN

Standard on all Microwell units, our Gold Fin process is an **anti-corrosion** coating that forms a protective shield so the unit can withstand virtually any environment (**sea side, acid rain, chlorine, etc.**)



COMPATIBILITY
All HP range

CONTROL DISPLAY PLACEMENT

Microwell offers **3 installation options** of heat pump control panel:

- Outside (on the unit)
- Remote (30 m)
- Wall



COMPATIBILITY
All HP range

MODEL	Pool capacity (cover / no cover)	Heating output (A26/W26/ 35 - 80%RH)	COP (A26/W26/ 35-80%RH)	Power consumption (A26/W26/63%RH)	Heating capacity (A26/W26/63%RH)	Cooling capacity (A30/W35)	Operating temperature	Water flow		Power supply	Heat exchanger	Titanium surface	Acoustic pressure level	Water circuit connection	Dimensions						
	m ³	kW	COP	kW	kW	kW	°C	m ³ / h	kPa	V AC / ph	type	m ²	dB (A)	mm/inch/ thread	width / height / length						
HP 1000 Compact OMEGA	40 / 30	9.7 - 13.1	5.2 - 7.0	1.88	10.7	6.5	-15 to +40	4 - 6	5 - 15	230 / 1	Titanium Gr 2 ASTM B358	0.43	54/48/42/36	50 / 6.4 / internal	870 x 870 x 320						
HP 1000 Split OMEGA								870 x 655 x 320													
HP 1100 Compact PREMIUM		10.3 - 13.9	5.9 - 7.9	1.74	11.3	7.2		4 - 6	1 - 5						870 x 870 x 320						
HP 1100 Split PREMIUM								870 x 655 x 320													
HP 1400 Compact OMEGA	60 / 40	12.8 - 17.2	5.2 - 7.0	2.47	14.1	9.5		4 - 6	5 - 15			230 / 1	Titanium Gr 2 ASTM B358		0.48	55/49/43/37	870 x 870 x 320				
HP 1400 Split OMEGA								870 x 655 x 320													
HP 1500 Compact PREMIUM		12.9 - 17.4	5.9 - 7.9	2.29	14.9	10.3		4 - 6	1 - 5						870 x 870 x 320						
HP 1500 Split PREMIUM								870 x 655 x 320													
HP 1000 GREEN On-Off	40/30	9.9 - 13.1	5.4 - 6.5	1.92	10	6.8		4 - 6	15			230 / 1	Titanium Gr 2 ASTM B358		0.42	52/43	1045 x 710 x 440				
HP 1000 GREEN Inverter PRO		10.4 - 13.2	3.2 - 13.2	1.72	10.7	7.6		3.5	14						0.52	52/40	1050 x 709 x 440				
HP 1400 GREEN On-Off	60/40	13.5 - 17.0	5.6 - 6.5	2.53	13	8.1		4 - 8	15						0.48	54/44	1045 x 710 x 440				
HP 1400 GREEN Inverter PRO		12.7 - 16.8	3.7 - 13.5	2.09	12.8	9.5		4	14						0.7	54/40	1050 x 870 x 450				
HP 1700 Compact	70 / 50	14.7 - 21.2	4.6 - 6.2	3.47	17.01	12.21		6 - 8	5 - 15						230 / 1	Titanium Gr 2 ASTM B358	0.95	56/50/43/39	1125 x 707 x 453		
HP 1700 Split								1125 x 707 x 453													
HP 2300 Compact INVENTOR	80 / 60	20.9 - 27.2	5.8 - 7.6	3.59	23	20.1		8 - 10	5 - 15								400 / 3	Titanium Gr 2 ASTM B358	0,95	56/50/44/38	942 x 1550 x 360
HP 2300 Split INVENTOR								942 x 1250 x 360													
HP 2400 Compact PREMIUM		20 - 27.2	6.5 - 8.5	3.51	24.4	21.7	8 - 10	1 - 5	1.2	942 x 1550 x 360											
HP 2400 Split PREMIUM							942 x 1250 x 360														
HP 2800 Compact INVENTOR	120 / 80	25.8 - 33.5	5.8 - 7.6	4.44	28.4	25.0	8 - 12	5 - 15	400 / 3	Titanium Gr 2 ASTM B358	1,1			56/50/44/38			942 x 1550 x 360				
HP 2800 Split INVENTOR							942 x 1250 x 360														
HP 3000 Compact PREMIUM		27.4 - 35.5	6.5 - 8.5	4.34	30.1	26.8	8 - 12	1-5			1,4						942 x 1550 x 360				
HP 3000 Split PREMIUM											942 x 1250 x 360										

Microwell reserves the right to change the technical data without notice.

STANDARD EQUIPMENT:

- MICROWELL HP heat pump
- Circulation pump control
- microCOMPRESSOR+
- microECONOMY+
- User manual

ACCESSORIES:

- Winter module
- Heat exchanger frost protection
- Condensate tray defrost
- Protection cover
- Control panel placement
- Hydro kit
- Split model connection length
- WIFI



HIGH-CAPACITY POOL DEHUMIDIFIERS

RECUPERATIVE DESIGN

Recuperative models (WRC and WRG) use exclusively exterior air to control the humidity. Their efficiency tops **75%**. Low Pressure Hot Water or electrical heater is used to balance the heat losses.

MATCHLESS ACCESSORY OPTIONS

All three WRC, WRG and WRPC series are equipped with the widest range of accessories to complete their flexibility and response to onsite demands.

from **700 to 4500 m³/h**



AVAILABLE IN
2 sizes

WRG SERIES

Heat recovery up to magnificent **95%** throughout counter flow recuperative heat exchanger places WRG series on the top of recuperative dehumidifiers. Available in 5 sizes from 700m³/h to practical **4.500m³/h**, the models can serve smaller commercial projects with focus on economy.

from **4 to 60 kg/h** - up to **160 m²**

from **700 to 9500 m³/h**

WRC SERIES

Using cross flow heat exchanger, WRC series achieves as high as **75%** heat recovery. Available in strong 7 sizes from 700m³/h to massive **9.500m³/h**, units are suitable for effective and economy humidity control in commercial projects.



AVAILABLE IN
7 sizes

from **4 to 60 kg/h** - up to **200 m²**

from **3000 to 9500 m³/h**



AVAILABLE IN
4 sizes

WRPC SERIES

Combining 2 the most efficient ways of humidity control, the WRPC models achieve **100%** heat recovery throughout using recuperative and heat pump principle. Built in 4 sizes from 3.000m³/h to **9.500m³/h**, the units are applied in large scale commercial projects where performance is the key.

from **17 to 60 kg/h** - up to **200 m²**



WATCH VIDEO & LEARN MORE



QMAX HEAT PUMP TESTER

MOBILE POOL SPECIALIST

OPERATION MEASUREMENT

After Qmax Tester is connected to swimming pool waterway between heat pump and outlet and water flows through the device, it begins measuring heat pump's performance. In only a few minutes it delivers detailed measurement, and reads off six different measurements; Coefficient of performance (COP), Energy efficiency ratio (EER), true heating or cooling output (kW), heat pump power consumption, water temperature and water flow in m³/h.

PERFORMANCE OPTIMIZATION

With Qmax Tester it is possible to adjust and optimise the water flow for a particular heat pump in real time. Qmax Tester can be applied to brand-new or existing installations, increasing the actual performance of a heat pump by up to 30% without the change in power consumption.

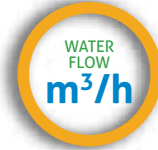

Compatible
WITH ALL
1 and 3 PHASE
HEAT PUMPS



Qmax Heat pump TESTER.
Setting the quality of pool performance.

NO MORE FALSE DATA

One of the most problematic aspects of today's industry are misleading performance results. Heating outputs and COPs are unreliably increased by up to 40%. This harms both the consumer and the heat pump's image. To disclose false claims and to show real data, Microwell has designed Qmax Tester.

TRUE RESULTS

Qmax is connected to water way between the heat pump and the pool. As the water flows through the device, Qmax performs detailed testing, displaying all technical data and performs full optimisation of the heat pump. In no more than 15 minutes!

INDUSTRIAL DEHUMIDIFIERS

HUMIDITY
OPERATING
30-95
RANGE

ENERGY
CONSUMPTION
1.4
kW

OPERATING
RANGE
0-35
°C



3 SIZES FOR COMPLETE HUMIDITY EXTRACTION

Microwell industrial dehumidifiers are high-performance mobile appliances designed for high volume moisture extraction. With capacities of **40, 90** and **120** litres per day they are well suited for any application. Often multiple units can be combined in a single application to provide massive yet very mobile drying. Additional electrical heater can be included with a dehumidifier to help speed up the drying process. As the applications are often harsh, all machines are extremely durable.

T40 / TE40



up to 40 l/day

FIT FOR HARSH TEMPERATURES

Equipped with a built-in electrical heating element, which ensures defrosting of the exchanger, Microwell industrial dehumidifiers are capable of operating at temperatures from 0°C to 35°C in any indoor area.

T90 / TE90



up to 90 l/day

APPLICATION OPTIONS

New construction sites, humid, drying up buildings, non-heated rooms, cellars, warehouses, switch rooms, filling stations, sports halls, garages, buildings flooded by water after fire-fighting to avoid corrosion, etc.

HOUR COUNTER

DUST FILTER

ELECTRICAL HEATER
2kW resistant heater

METAL COVER

T120 / TE120

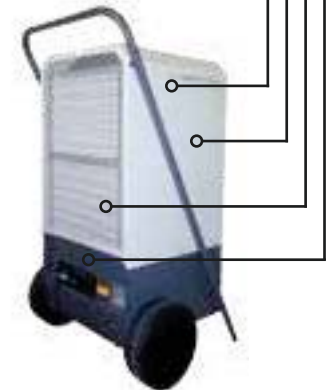

up to 120 l/day

MUSEUM DEHUMIDIFIERS

DISCREET DESIGN FOR ENCLOSED EXHIBITION ENVIRONMENT

DRY GALLERY 300/400 is an elegant and mobile solution for small exhibition spaces. With standard glossy white cabinet-like housing on wheels, it can be easily and non-intrusively placed in any environment. Specially adapted to work in exhibition spaces, the unit is especially quiet and has low vibration levels. Each unit is equipped with 20-liter condensation tank and continuous drainage.

APPLICATION VARIETY

Museum properties, dehumidification of galleries also offices, storage rooms, archives, warehouses, etc.

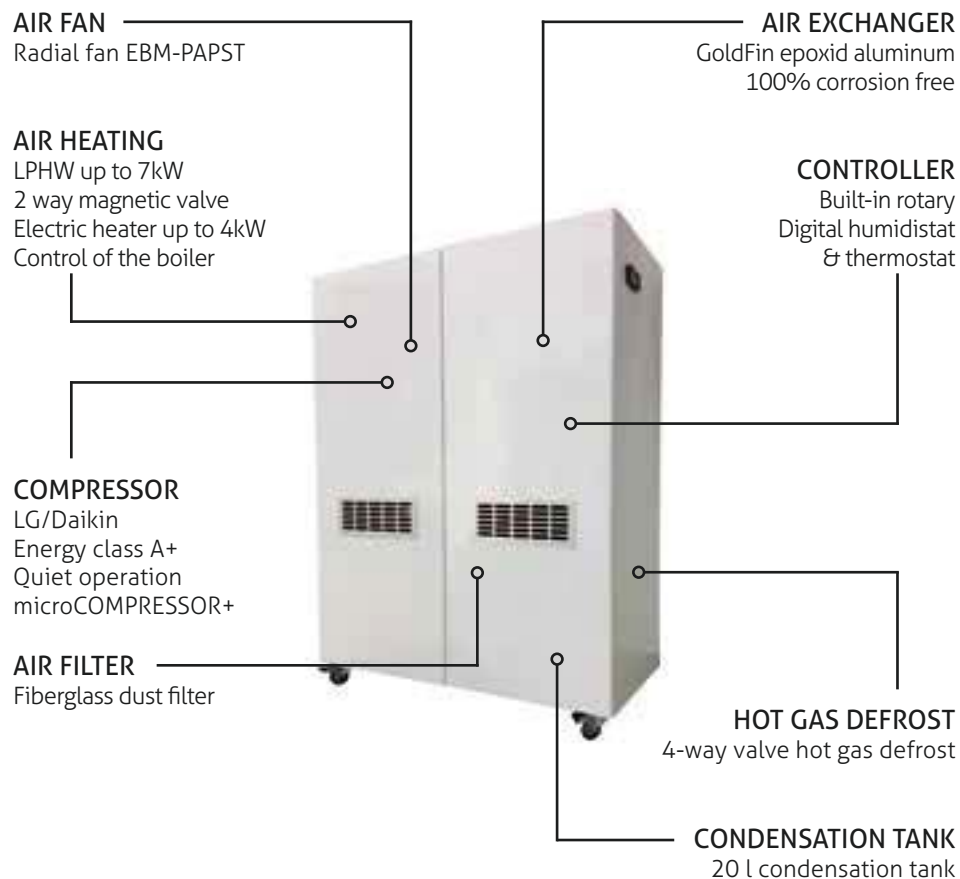

WOOD FINISHES



BEECH



CHERRY



OAK

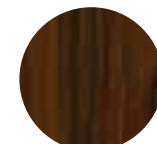

NUT

up to 48 l/day



micro CONTROL +



Technology of the most precise and most economy humidity control. It is applied for ducted types of dehumidifiers. microCONTROL+ shortens the problem solving time and overall contributes to healthier environment sooner and more effective than any other dehumidifier.

easy INSTALL +



Microwell machines are designed as plug-n-play devices. Typically, installation can be comfortably performed by a single technician or pool owner himself.

micro ECONOMY +



Technology of a circulation pump control. Microwell swimming pool heat pump with microECONOMY+ ensures heating of your pool sooner and cheaper than any other swimming pool heat pump.

anti FREEZE +



Microwell unique protection to avoid damage of your property or the heat pump in subzero temperatures.

micro ENERGY +



Dehumidifiers marked with microENERGY+ are equipped solely with the most energy saving DC fans. These bring the necessary performance, quiet operations and save costs on energy bill every day.

anti VIBRATION +



Special vibration eliminating silent blocks are by standard included with all Microwell heat pumps.

micro COMPRESSOR +



Special compressors integrated with maximally finetuned working point for the dehumidifiers and for the heat pumps achieving highest performance at lowest energy consumption.

ultra QUIET +



This mark stands for exceptional silence of the unit.
42 dB (A) at 1m distance for dehumidifiers
30 dB (A) at 10m distance for heat pumps

micro SAFETY +



microSAFETY+ is a supervision system in DRY SIREN models. The system monitors each DRY SIREN. In the case of a sign of technical problem or possible malfunction, the system creates a report and automatically sends it to Microwell. microSAFETY+ effectively protects your property 24/7. The data is securely ciphered.

MICROWELL REFERENCES



VARIETY OF MODELS TO FIT EVERY POOL

WIDEST RANGE OF DESIGN AND ACCESSORY OPTIONS

EXCELLENT WORKMANSHIP

COMPETITIVE PRICES

PRODUCTS MANUFACTURED IN EUROPE

UP TO 5 YEARS WARRANTY

SELLING TO 30+ COUNTRIES WORLDWIDE

27 YEARS OF BUSINESS EXPERIENCE

ACCREDITED BY ISO 9001, ISO 14001, ISO 18001

WHY MICROWELL?



PRODUCT OF THE YEAR 2005
PRODUCT OF THE YEAR 2013



PRODUCT OF THE YEAR 2014



RECOGNITION PRIZE 2014



LOW ENERGY CONSUMPTION 2017



LUXURY DESIGN 2017



BEST EXHIBIT AWARD 2017



BUSINESS SUPERBRANDS
AWARD 2019



Microwell is European designer and manufacturer of dehumidification solutions and heating systems from Slovakia. From its foundation Microwell is firmly present on the global market, where it is recognised as a leading expert for swimming pool dehumidification and heating solutions.

With distributors and partners in 30+ countries across Europe, Russia, Middle East and North Africa, Microwell capitalises the flexibility and strategic position only to explore new opportunities leading to new intelligent products.

By fostering innovation, Microwell remains true to its core company value and commitment.

Committed to efficiency.



www.microwell.eu

MICROWELL, spol. s r.o.

SNP 2018/42
927 00 Šal'a
SLOVAKIA

p (+421) 31/770 7082
m (+421) 911/413 990

e export@microwell.sk

Branch office PRAGUE

Šifařská 1/3
147 00 Praha 4, CZ

m (+420) 608 855 387
m (+420) 773 621 599

e paha@microwell.cz

www.microwell.cz

Branch office BRNO

Bohunická 81
619 00 Brno, CZ

p (+420) 549 257 241
m (+420) 777 550 482

e klimatizace@microwell.cz

www.microwell.cz

Branch office OSTRAVA

Slévárenská 411/12
709 00 Ostrava, CZ

p (+420) 596 638 227
m (+420) 608 855 364

e microwell@microwell.cz

www.microwell.cz

Branch office BUDAPEST

Rákóczi utca 42
2092 Budakeszi, HU

p (+36) 23 399 404
m (+36) 30 875 58 51

e microwell@microwell.hu

www.microwell.hu

Widest Model Range.

Ultimate Performance.

The Lowest Energy Consumption Ever.



COMMITTED TO EFFICIENCY.

2019

